

The background features a dark blue gradient with a starry space pattern. On the left side, there are several technical diagrams, including circular gauges with numerical scales (140, 150, 160, 170, 180, 190, 200, 210, 220, 230, 240, 250, 260) and various circular arrows and lines, suggesting a complex system or data flow.

INTRODUCTION TO SSI

FINDY-AGENT - DECENTRALIZED IDENTITY AGENCY

 @harrilainio

SELF- SOVEREIGN IDENTITY

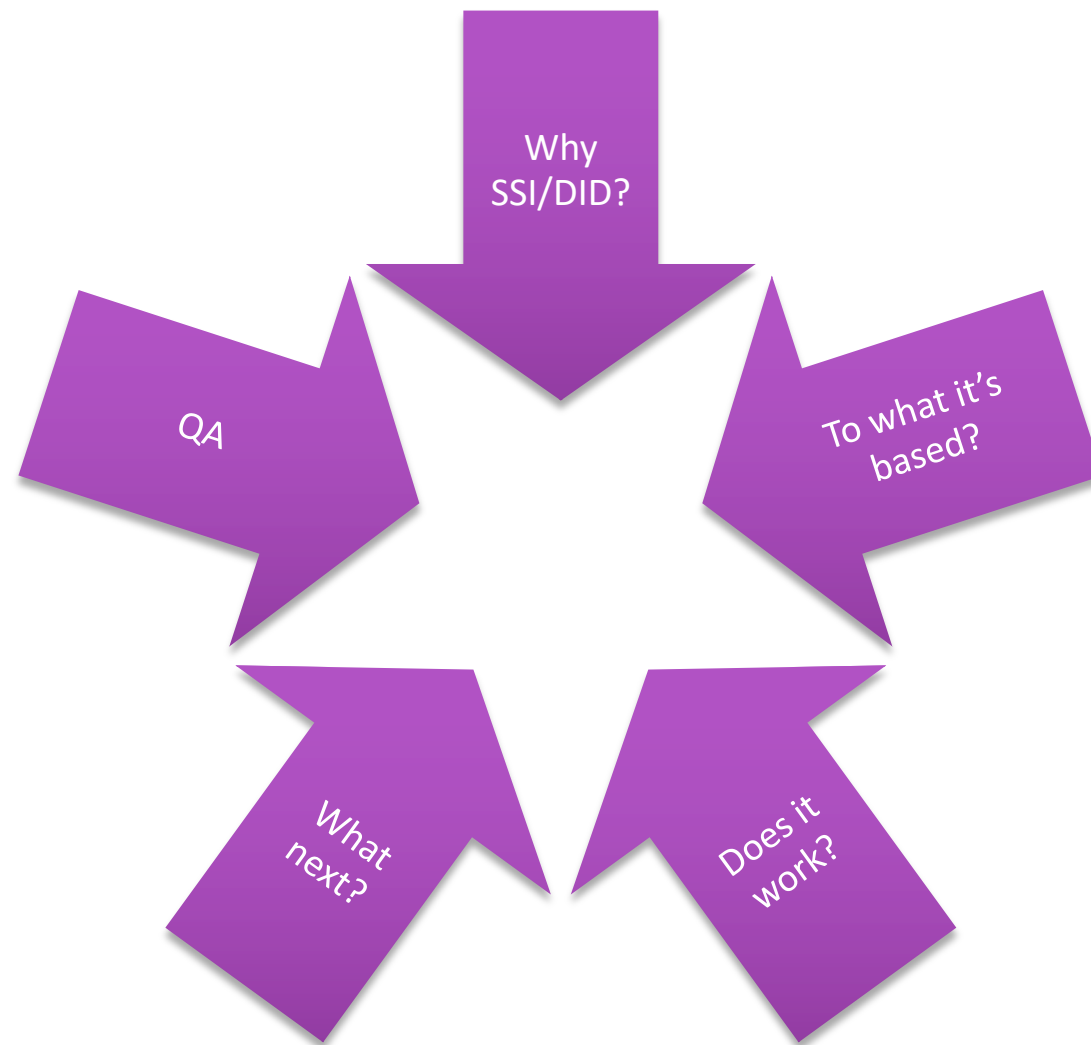

“ *Self-Sovereignty is the characteristic of every party that it is autonomous in managing and operating its own knowledge, particularly in making decisions and deciding how to decide.* ”

<https://essif-lab.github.io/framework/docs/terms/self-sovereignty>

Self-Sovereignty

LOWER UNCERTAINTY TO EXCHANGE VALUE

- Institutions to reduce uncertainty
- How to do it without 3rd party?



Federated Identity

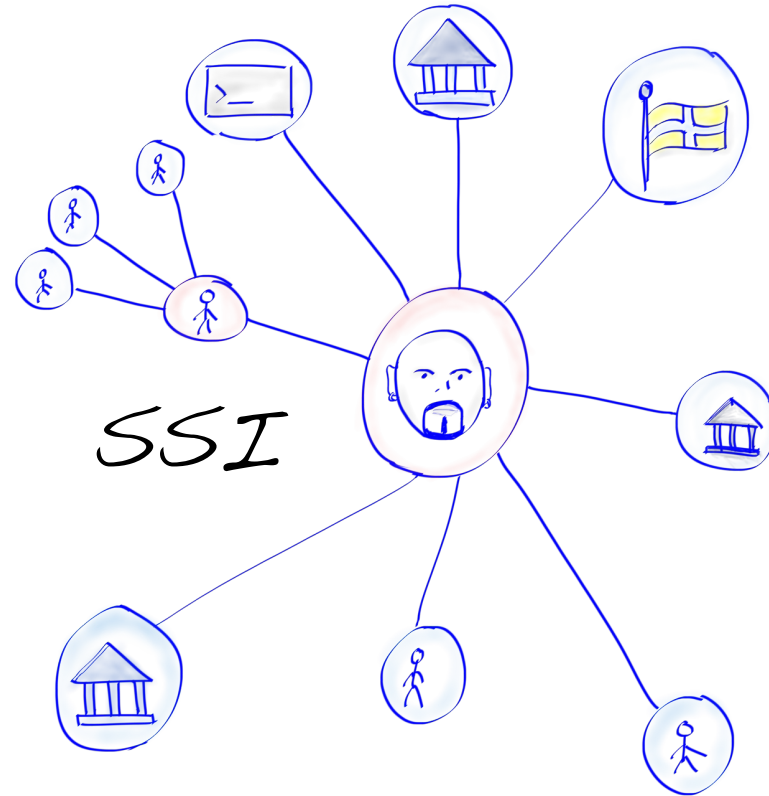
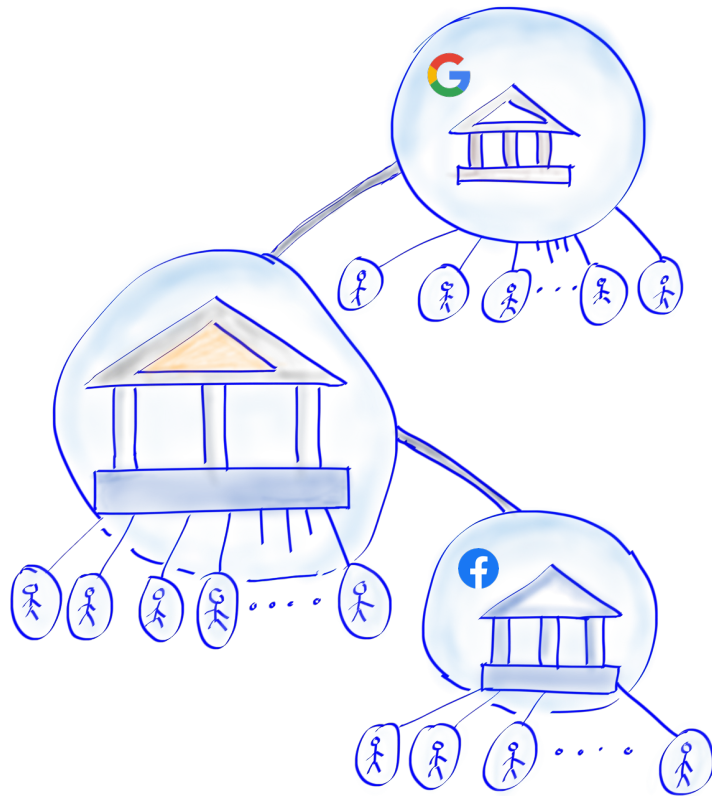

Identifiers

sfsnoknas6agfbymb73mjr2c2d16tyhamu7x4z4i3u55adhkv7tj2cqd.onion

192.168.50.21

ABC-123

harri.lainio@op.fi

www.op.fi

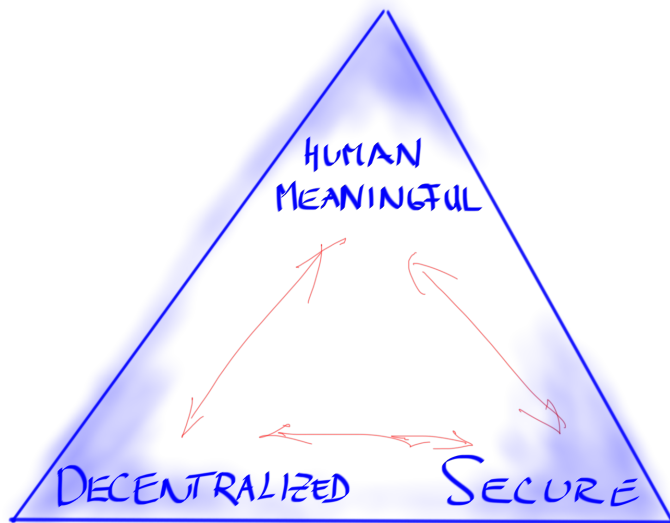

Zooko's Triangle



Idea of Using Blockchain

did:peer:1zQmQSLFWySB3LACeSrUpvM48QN9frMayNHypnsQjk4GhQKG

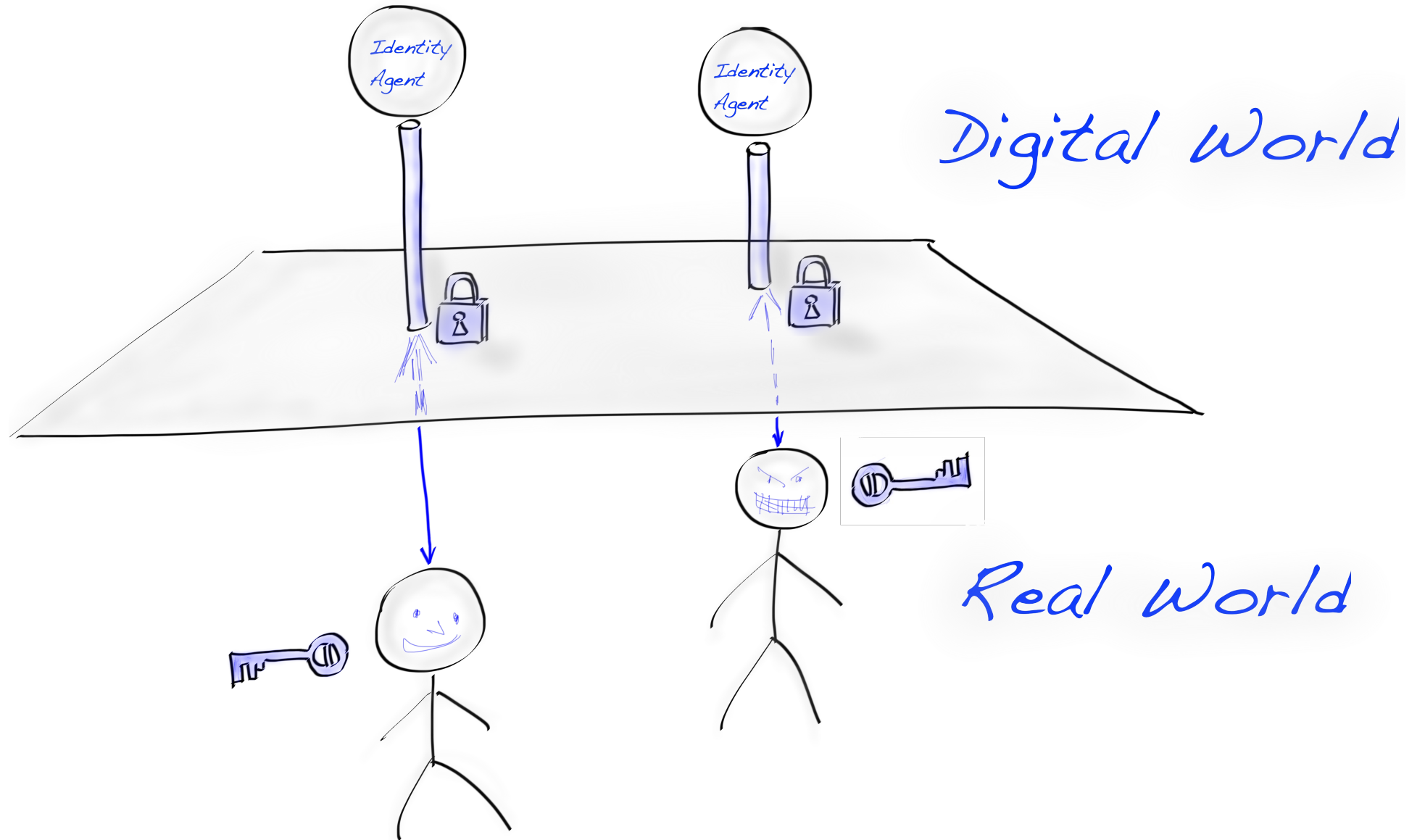

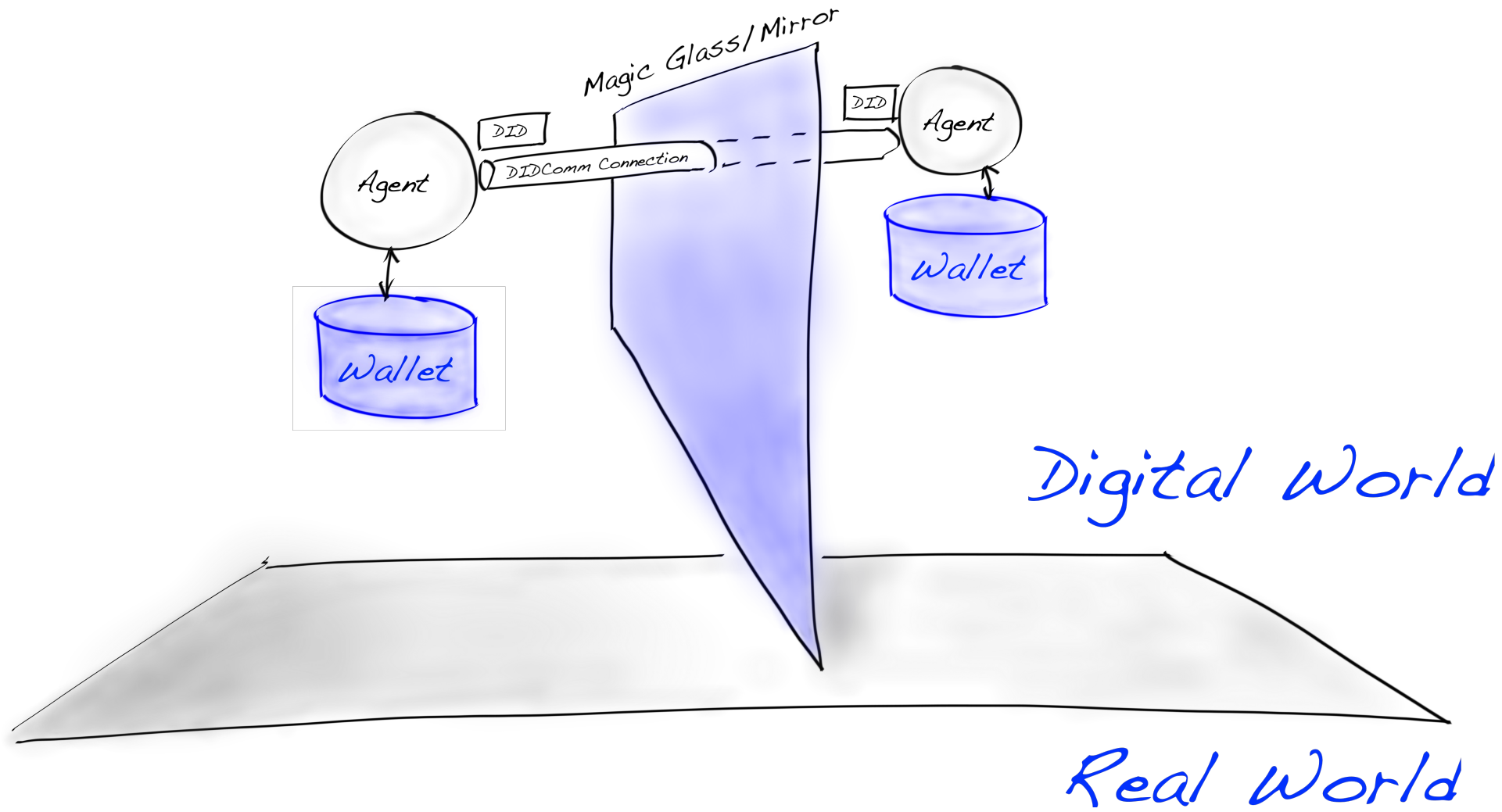

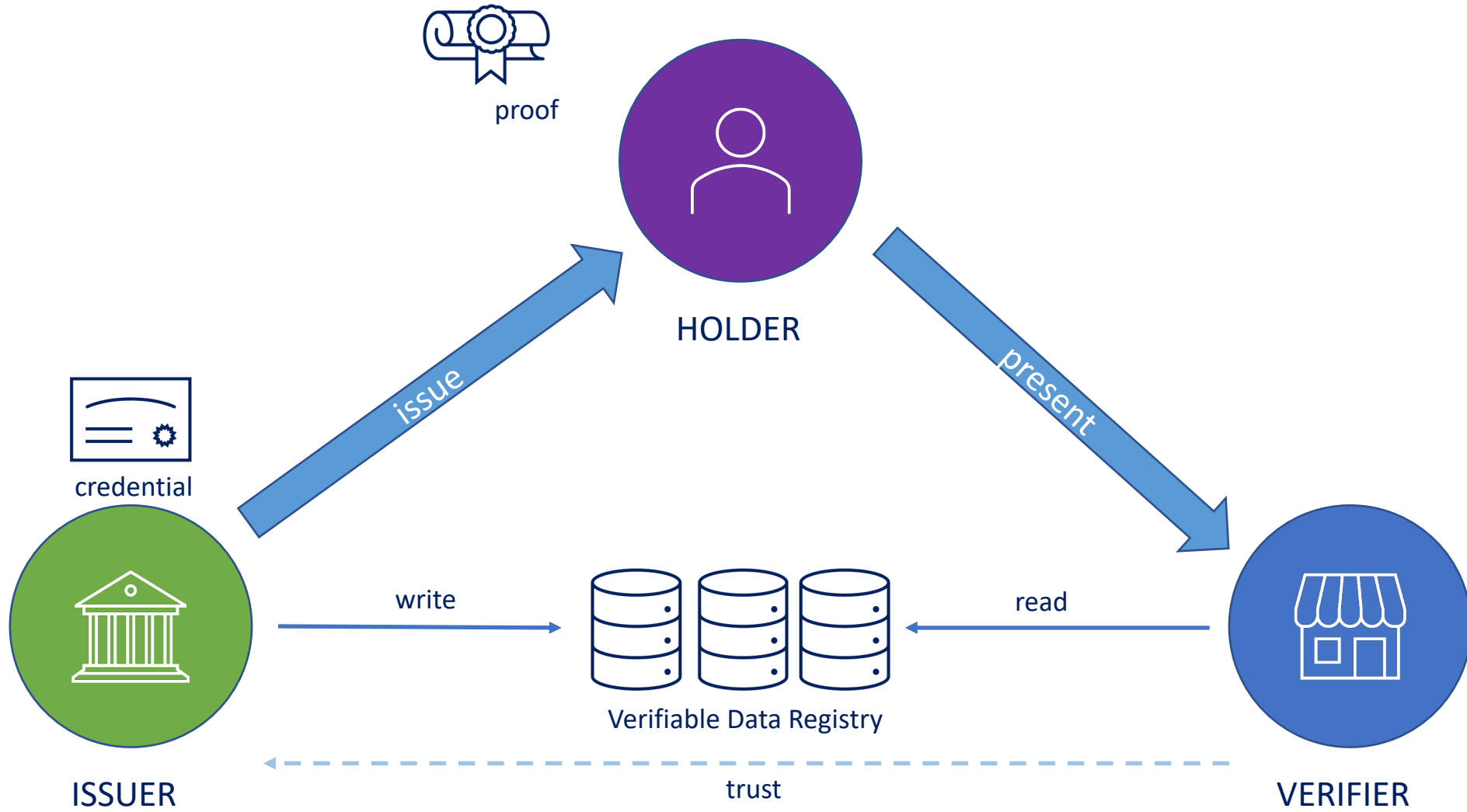



SSI AGENCY

[HTTPS://FINDY-NETWORK.GITHUB.IO](https://findy-network.github.io)

<https://findy-network.github.io>

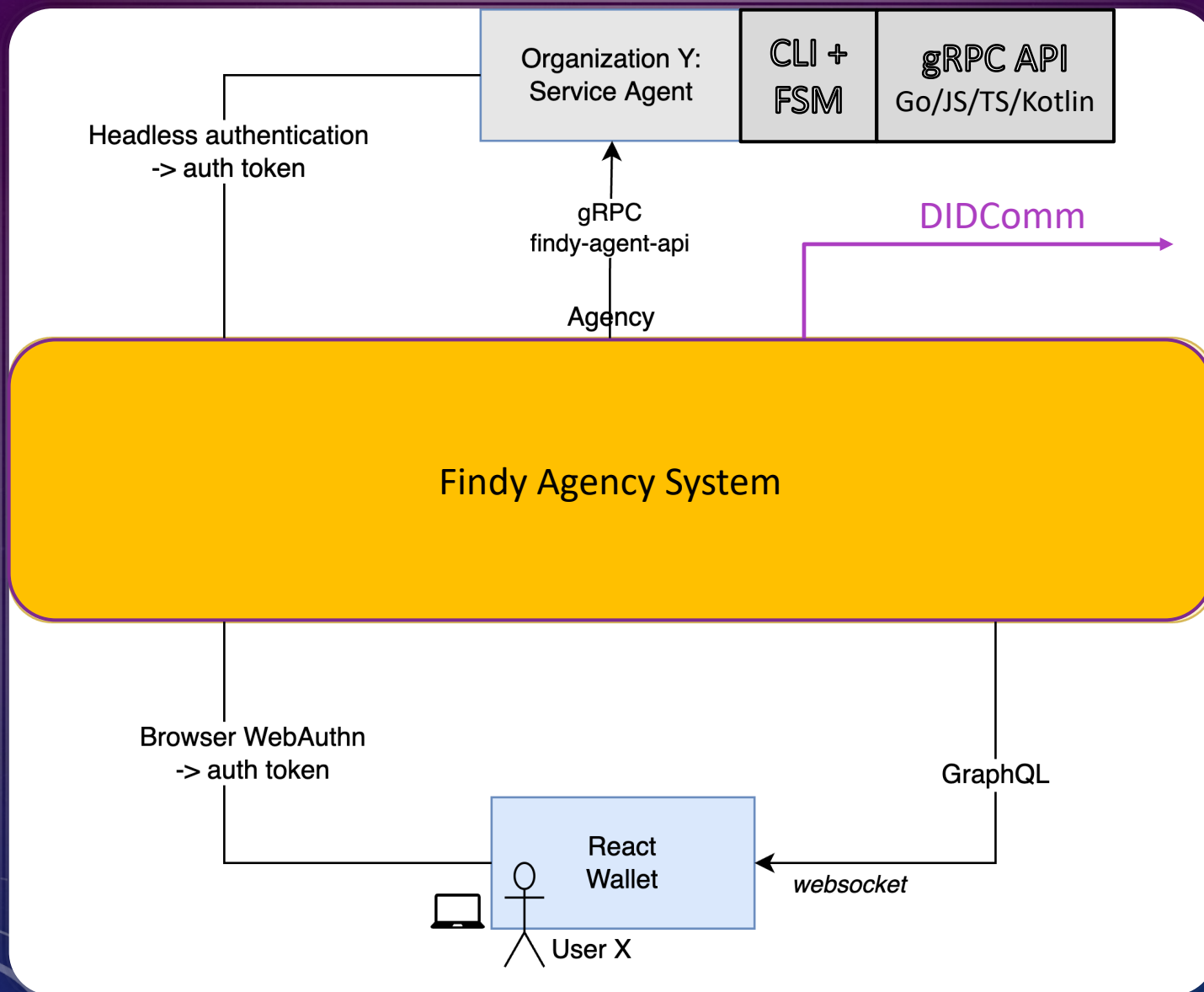

FINDY - SSI AGENCY

- FIDO2 Authentication
- JWT Authorization
- gRPC -> polyglot API
- GraphQL
- Mutual TLS
- Containerized
- Go Implementation
- Outstanding Performance
- Standalone Dev Model

OPEN-SOURCE SOFTWARE

Multi-repos

Well documented

Lots of examples

Docker images are public and available

Batteries included

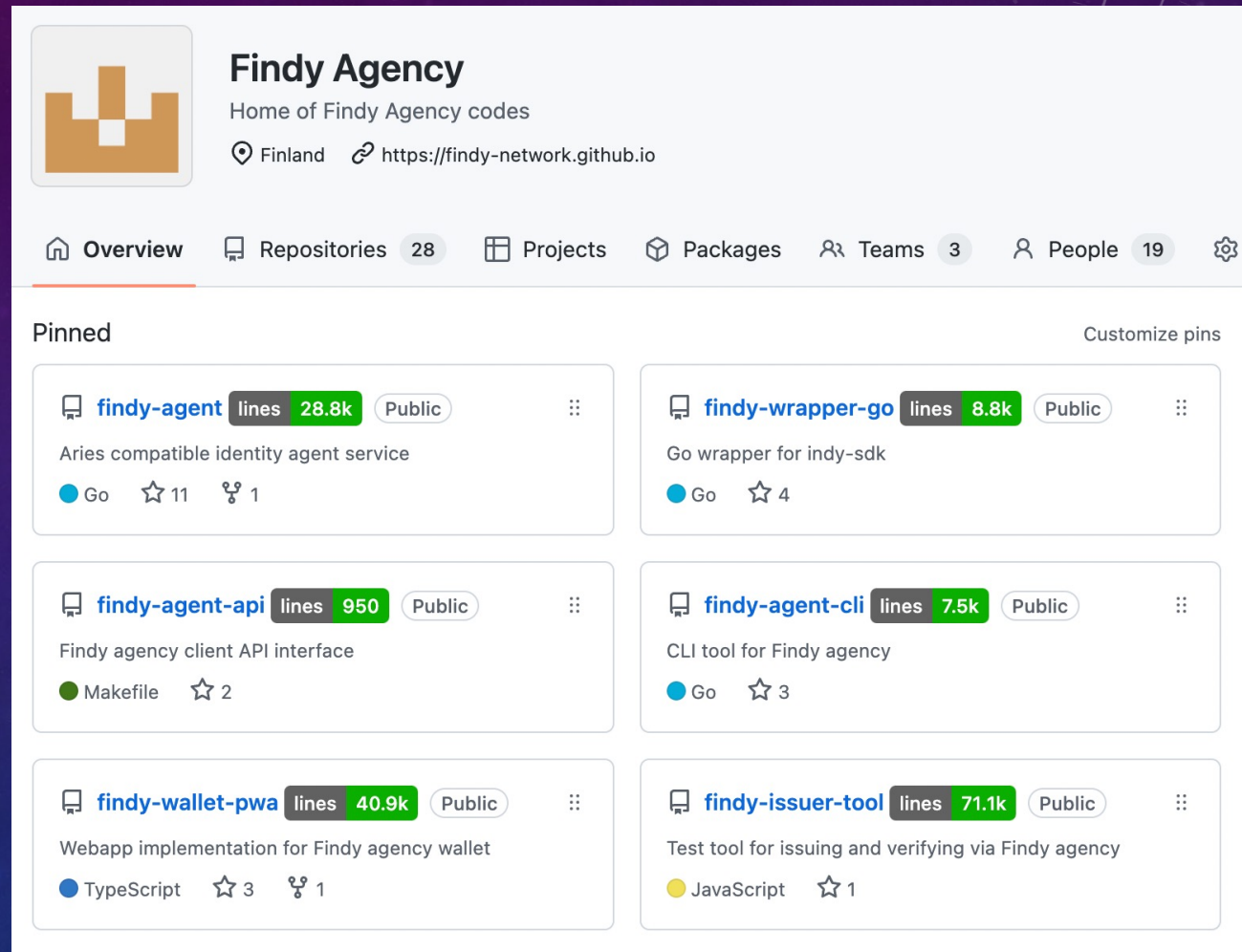

The screenshot shows the GitHub profile for Findy Agency. The profile header includes the repository name, location (Finland), and website (https://findy-network.github.io). Below the header is a navigation bar with tabs for Overview, Repositories (28), Projects, Packages, Teams (3), and People (19). The main content area is titled "Pinned" and displays six repository cards in a 3x2 grid. Each card shows the repository name, language, line count, and public status. The repositories are: findy-agent (Go, 28.8k lines), findy-wrapper-go (Go, 8.8k lines), findy-agent-api (Makefile, 950 lines), findy-agent-cli (Go, 7.5k lines), findy-wallet-pwa (TypeScript, 40.9k lines), and findy-issuer-tool (JavaScript, 71.1k lines). Each card also includes a description, a star icon with count, and a fork icon with count.

Repository Name	Language	Lines	Public	Description	Stars	Forks
findy-agent	Go	28.8k	Public	Aries compatible identity agent service	11	1
findy-wrapper-go	Go	8.8k	Public	Go wrapper for indy-sdk	4	0
findy-agent-api	Makefile	950	Public	Findy agency client API interface	2	0
findy-agent-cli	Go	7.5k	Public	CLI tool for Findy agency	3	0
findy-wallet-pwa	TypeScript	40.9k	Public	Webapp implementation for Findy agency wallet	3	1
findy-issuer-tool	JavaScript	71.1k	Public	Test tool for issuing and verifying via Findy agency	1	0

THANK YOU!

HARRI.LAINIO@OP.FI

<https://findy-network.github.io>

13

